

Article number: 20036461

Description: E+G Ball knob DIN 319-KT-40-M12-C

Measures

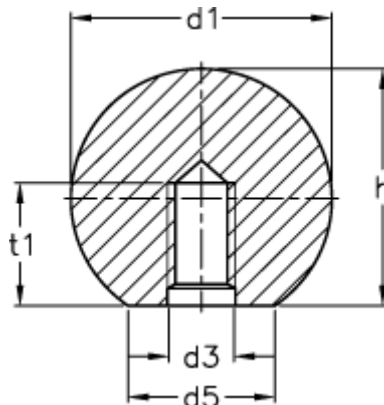

d1	= 40
d3	= M12
d5	= 22
h	= 37.0
t1 min.	= 18.0